

# HiRise Deluxe

adjustable desktop stand for iPhone + iPad  
owner's guide



twelvethsouth

# What's in the box?



Rear Support



Rear Support Screw  
(attached to Base)

Lightning  
Cable



Micro USB  
Cable

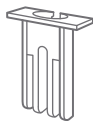
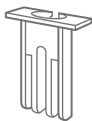
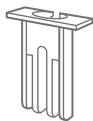

Cable Clip (3)

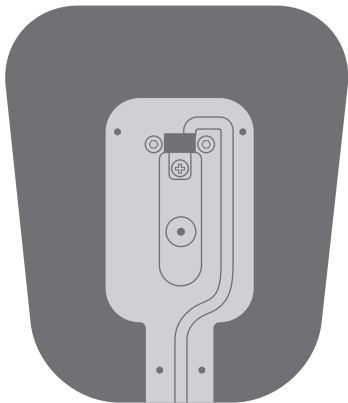

Base



Base Cap

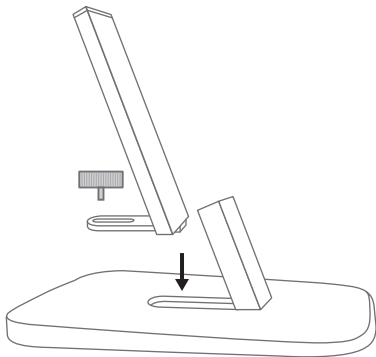

Remove Rear Support Screw from Base.  
Attach Rear Support to Base with Rear Support Screw.

1

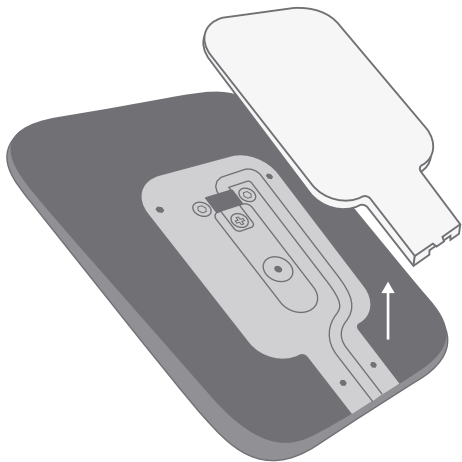

Remove Base Cap.

Thread Lightning or Micro USB cable through Front Support.

Lightning  
Cable



Micro  
USB

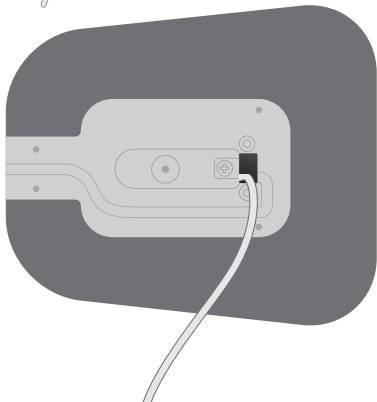
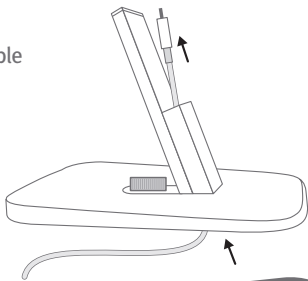

3

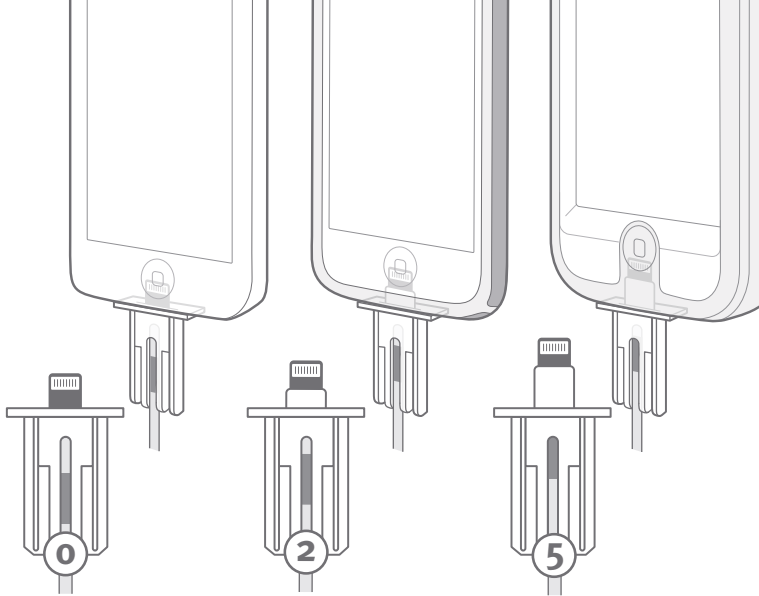

Choose the Clip that best fits your phone's case.

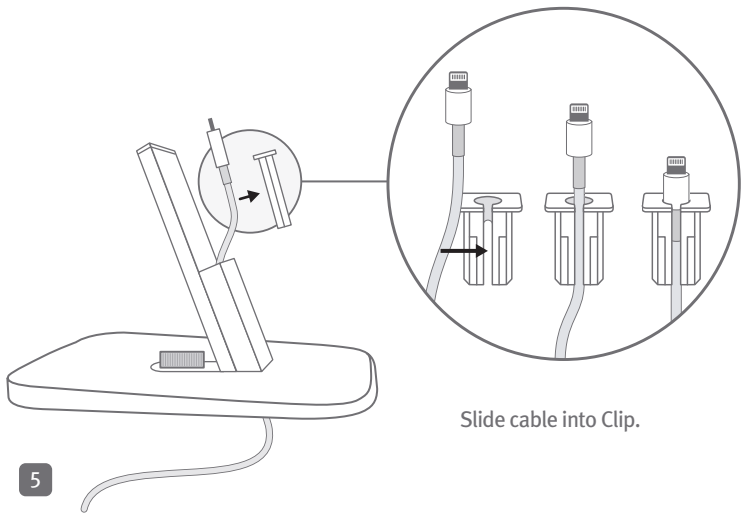



Insert Clip with cable into  
Front Support.

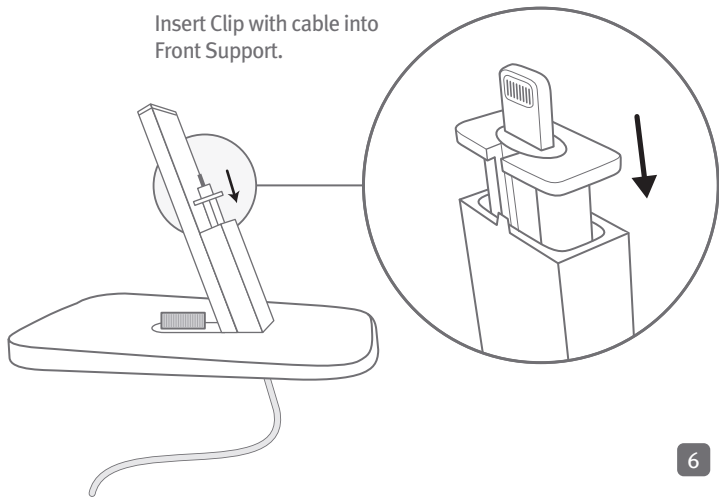

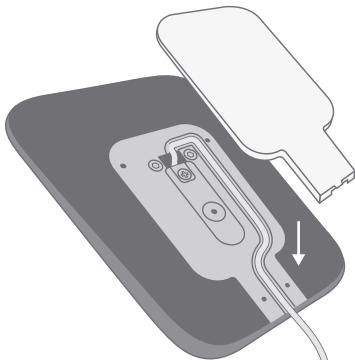
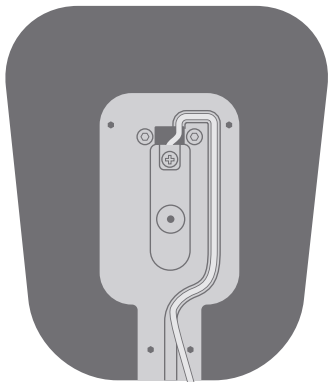

7

Route cable through channel on inside of Base. Replace Base Cap.

## Adjusting HiRise:

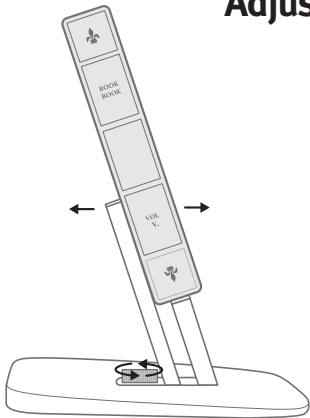

To adjust HiRise, loosen Rear Support Screw and slide Rear Support forward or backward. Re-tighten screw.

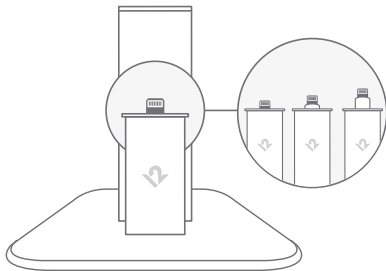

Clips elevate cable to fit into most protective cases.